

Technical data sheet

# 227C-024-10 Rotary actuator

## Description

Rotary actuator for adjusting dampers in HVAC installations

- Running time 150 s / 90°
- Torque 10 Nm
- Nominal voltage 24 VAC/DC
- Control continuous control (0)2...10 VDC
- Damper size up to approx. 2 m<sup>2</sup>
- Shaft coupling clamp  
Ø 8-15 mm / Ø 8-20 mm



## Technical data

Electrical data	Nominal voltage	24 VAC/DC, 50/60 Hz
	Nominal voltage range	19...29 VAC/DC
	Power consumption motor (motion)	2,0 W
	Power consumption standby (end position)	1,0 W
	Wire sizing	3,5 VA
	Control	continuous control (0)2...10 VDC / Ri > (100 kΩ) 50 kΩ (0)4...20 mA / Rext. = 500 Ω
	Feedback signal	(0)2...10 VDC, max. 5 mA
	Auxiliary switch	-
	Contact load	-
	Switching point	-
	Connection motor	cable 1000 mm, 4 x 0,75 mm <sup>2</sup> (halogen free)
	Connection feedback potentiometer	-
	Connection auxiliary switch	-
	Connection GUAC	-

## Technical data

<b>Functional data</b>	Torque	10 Nm	
	Damper size	up to approx. 2 m <sup>2</sup>	
	Synchronised speed	±5%	
	Direction of rotation	selected by switch	
	Manual override	Gearing latch disengaged with pushbutton, self-resetting	
	Angle of rotation	0°...max. 95° can be limited with adjustable mechanical end stops	
	Running time	150 s / 90°	
	Sound power level	< 35 dB(A)	
	Shaft coupling	clamp Ø 8-15 mm / Ø 8-20 mm	
	Position indication	mechanical with pointer	
	Service life	> 60 000 cycles (0°...95°...0°) > 1 000 000 partial cycles (max. ±5°)	
	<b>Safety</b>	Protection class	III (safety extra-low voltage)
		Degree of protection	IP 54 (cable downwards)
EMC		CE (2014/30/EU)	
LVD		CE (2014/35/EU)	
RoHS		CE (2011/65/EU - 2015/863/EU - 2017/2102/EU)	
Mode of operation		Typ 1 (EN 60730-1)	
Rated impulse voltage		0,8 kV (EN 60730-1)	
Control pollution degree		3 (EN 60730-1)	
Ambient temperature normal operation		-30°C...+50°C	
Storage temperature		-30°C...+80°C	
Ambient humidity		5...95% r.H., non condensing (EN 60730-1)	
Maintenance		maintenance free	
<b>Dimensions / Weight</b>		Dimensions	115 x 65 x 61 mm
	Weight	350 g	

## Functionality / Properties

### Operating mode

Connect power supply to wire 1+2 and a reference signal Y to wire 3 in range of (0)2...10 VDC, actuator drives to its specified position. The actual damper position (0...100%) is a feedback signal U on wire 4 for example to share with other actuators. The actuator is overload-proof, requires no limit switches and automatically stops, when the end stop is reached.

### Direct mounting

Simple direct mounting on the damper shaft with a clamp, protection against rotating with enclosed anti-rotation lock or rather at intended attachment points.

### Manual override

Manual override with self-resetting pushbutton possible (the gear is disengaged as long as the button is pressed).

### Mode switch

Mode switch with five positions at the housing:

- 2-10 R: rotary direction right 2-10 VDC
- 0-10 R: rotary direction right 0-10 VDC
- Adp: adaption
- 0-10 L: rotary direction left 0-10 VDC
- 2-10 L: rotary direction left 2-10 VDC

### Adaption drive

- Actuator power off
- Setting the mechanical end stops
- Actuator power on
- Adaption enable
- Actuator drive to position 0
- Actuator drive to position 1
- Adaption disable, if desired angular range reached or rather if actuator reached endstop
- "Y" refers to the measured angular range

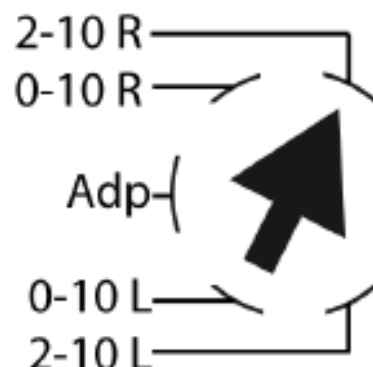

## Connector / Security Note

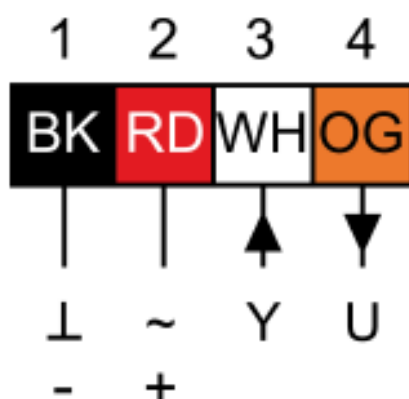

### Safety remarks

- Connect via safety isolation transformer!
- The device is not allowed to be used outside the specified field of application, especially in airplanes.
- It may only be installed by suitably trained personnel. Any legal regulations or regulations issued by authorities must be observed during assembly.
- The device may only be opened at the manufacturer's site.
- The device is not allowed to be disposed of as household refuse. All locally valid regulations and requirements must be observed.
- When calculating the required torque, the specifications supplied by the damper manufacturer's (cross-section, design, installation site), and the air flow conditions must be observed.

## Technical Drawing

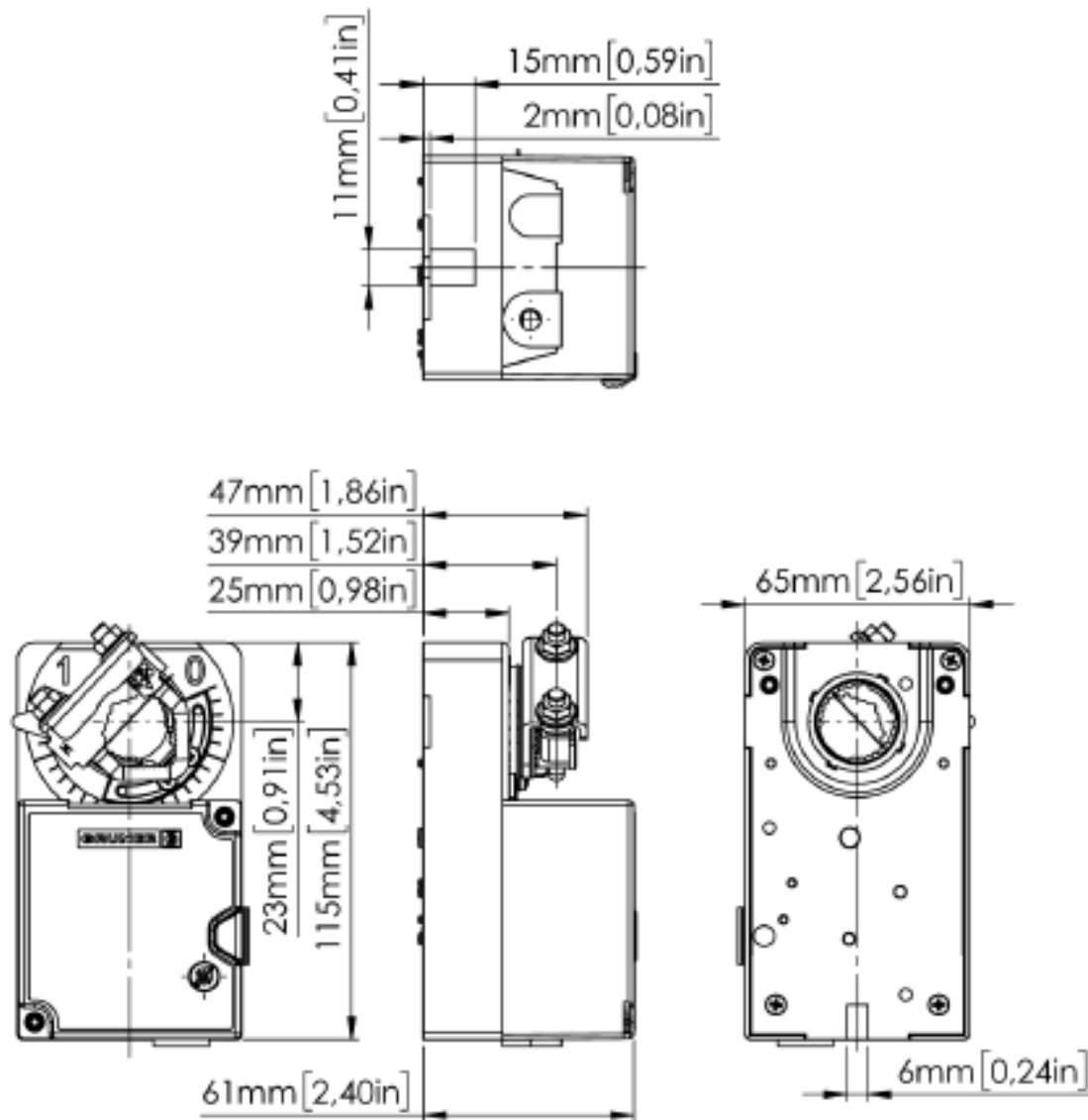

Technical data sheet

**Control ball valve**  
**BOFB...K...B (2-way valve)**  
**BOLB...K...B (3-way valve)**

Description

Control ball valve to control the flow of hot and cold water and Glykol solutions (max. 50%) in HVAC systems conjunction with a rotary actuator



Technical data

<b>Valve</b>	Flow disc	with and without flow disk
	Media	- hot and cold water (VDI 2035) - water with glycol (max. 50%) - steam 121°C at 103 kPa
	Temperature of medium	-30°C...+140°C
	Body pressure rating	PN 40
	Close-off pressure ps	1380 kPa
	Differential pressure pmax	600 kPa (without flow disk) 340 kPa (with flow disk)
	Differential pressure note	240 kPa (low noise operation)
	Flow characteristic	equal percentage at 2-way/3-way valve linear at 3-way valve in bypass (VDI/VDE 2178)
	Leakage rate	< 0.01% from the Kvs, < 1% for bypass port leak-proof
	Connection	female thread (Rp, ISO 7/1)
	Angle of rotation	0...max. 90°
	Mounting position	vertical to horizontal (in relation to shaft)
<b>Materials</b>	Case	brass (DIN EN 12165, CW617N)

## Technical data

<b>Materials</b>	Valve ball	stainless steel (EN 10088-2)
	Valve shaft	stainless steel (EN 10088-2)
	Valve shaft gasket	2 x EPDM O-ring
	Gasket	PTFE with graphite part and EPDM O-ring
	Flow disc	AMODEL AS 1145HS
	Lubrication	accordance with approval
	<b>Safety</b>	CE
Maintenance		maintenance free
<b>Equipment</b>	Equipment	couplings inserts adapter
<b>Dimensions / weight</b>	Dimensions	see technical drawing

## Functionality / Properties

### Combination with actuator

The valves are according to the application with the listed actuators combined.

#### IP52:

- 225 - 24/230 VAC/DC - 5 Nm

#### IP54:

- 227 - 24/230 VAC/DC - 5; 10; 15

Nm

- 341 - 24/230 VAC/DC - 3; 5 Nm

### Ball valve flow

Kvs [m <sup>3</sup> /h]	DN	Kvs [m <sup>3</sup> /h]	DN
0,4	15	10	32
0,63		16	
1		• 25	
1,6		16	40
2,5		25	
4,0	20	• 40	50
• 10		25	
4,0		40	
6,3	25	• 63	• without flow disk
• 10			
6,3			
10			
• 16			

### Direct mounting

Simple direct mounting on the ball valve by closing the form of the shaft and screw, securing against rotation by twisting the adapter.

## Connector / Security Note

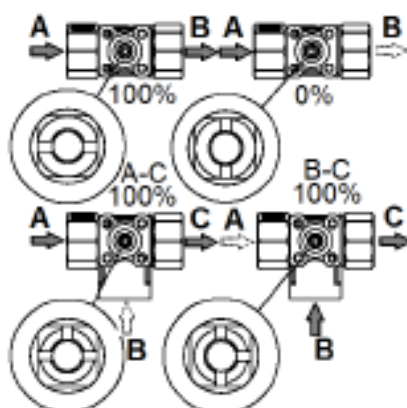
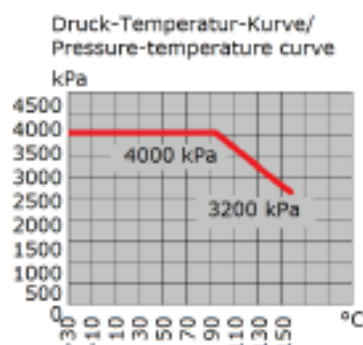

## Safety remarks

- The device is not allowed to be used outside the specified field of application, especially in airplanes.
- It may only be installed by suitably trained personnel. Any legal regulations or regulations issued by authorities must be observed during assembly.
- When determining the flow characteristic the accepted directives must be observed.
- The device is not allowed to be disposed of as household refuse. All locally valid regulations and requirements must be observed.

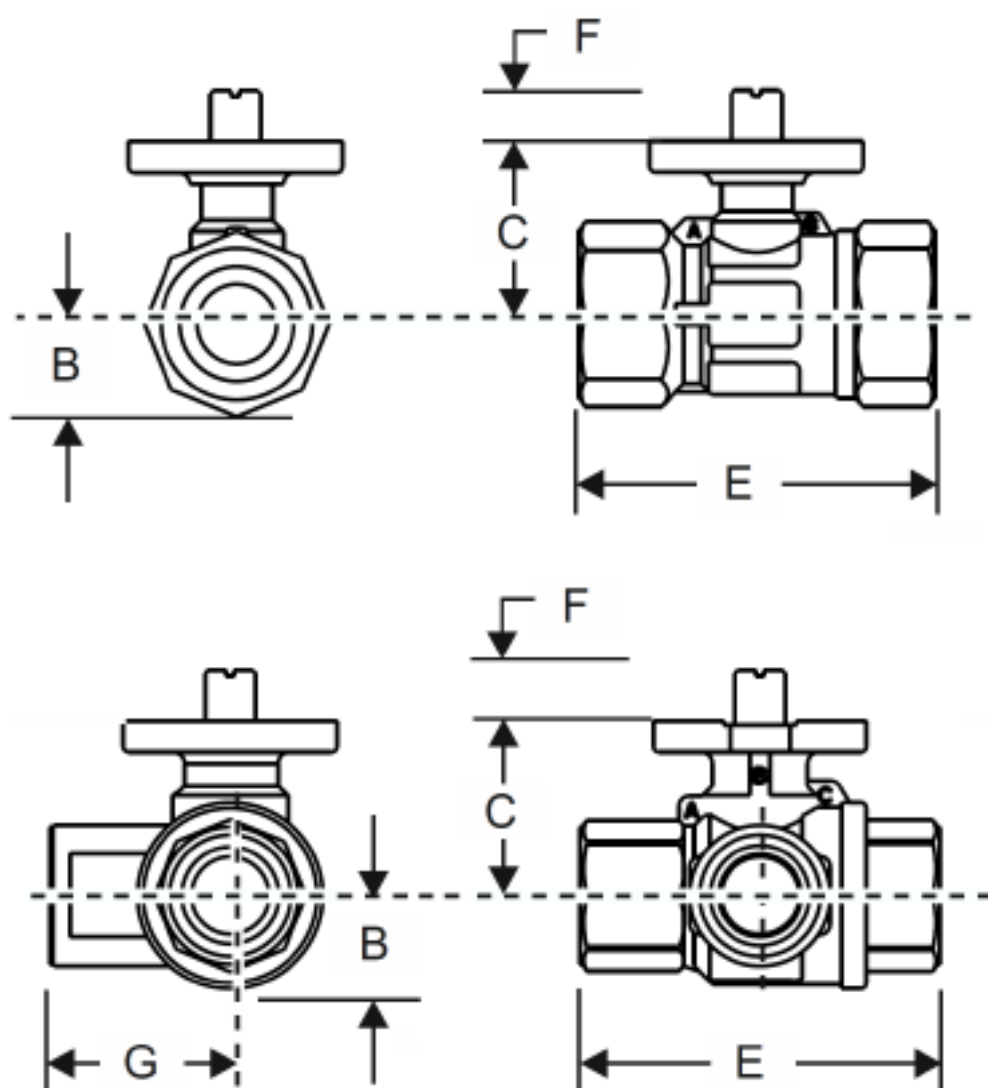
**Technical Drawing**

Valve	B	C	E	F	G*
DN 15	17	31	67	9	33
DN 20	17	31	75	9	38
DN 25	19	33	92	9	46
DN 32	26	44	109	9	54
DN 40	29	48	119	9	59
DN 50	37	53	139	9	74

\* Only for three-way valves



## Kvs diagram

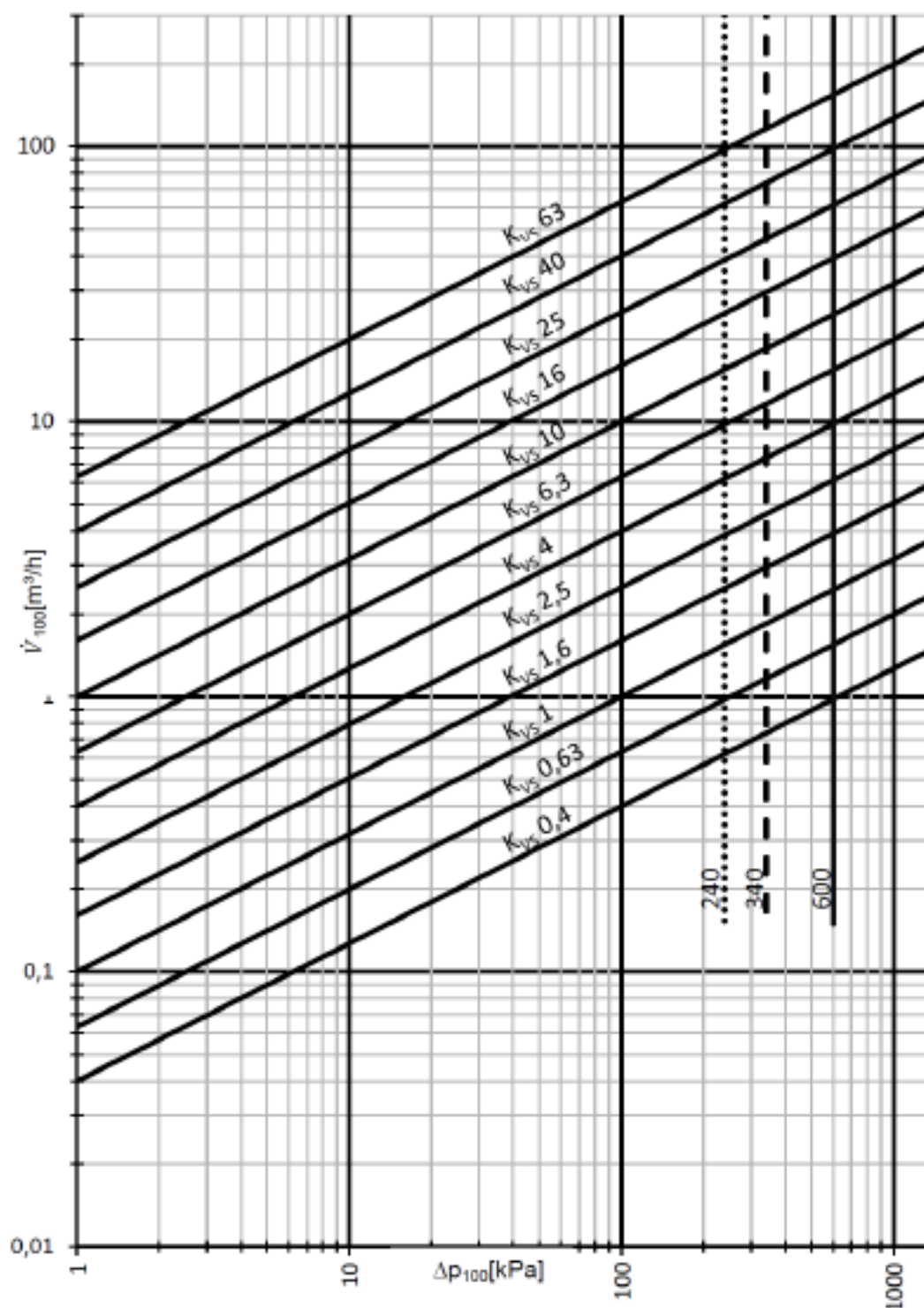

Formel Kvs-Wert Wasser  
Formula Kvs for water

$$\begin{array}{l}
 K_{vs} \quad [m^3/h] \\
 \dot{V}_{100} \quad [m^3/h] \\
 \Delta p_{v100} \quad [kPa]
 \end{array}
 \quad
 K_{vs} = \sqrt{\frac{\dot{V}_{100}}{\frac{\Delta p_{v100}}{100}}}$$