



## TRA-F121-A Fan coil controller with Modbus RTU

Document sections	Chapter	Page
General Description	1	2
Technical Specifications	2	4
Operation	3	6
Setting up the controller	4	12
Configuration (parameter options)	5	13
Runtime Data	6	30
Additional Information	7	32

## 1 General Description

The **TRA-F121-A** is a communicating electronic fan coil controller that controls the room temperature. It supports motorized valves and 1- or 3-speed fans in 2-pipe and 4-pipe fan coil units (heating or cooling).

Additional inputs can be used for external temperature sensor, room occupancy (motion) detection and more. The controller offers the operating modes Comfort, Economy and Protection.

The TRA-F121-A includes a Modbus RTU interface and can easily be integrated into a building automation system.

Typical application includes:

- Fan coil systems
  - 2-pipe fan coil (cooling or heating on/off valve)
  - 2-pipe fan coil with 3-position valve (cooling or heating valve)
  - 2-pipe fan coil and electric heater
  - 4-pipe fan coil (cooling and heating on/off valve)
- Floor heating systems (on/off or 3-position valve)
- Chilled ceilings or chilled beams systems (on/off or 3-position valve)

### 1.1 Features

- LCD display with backlight
- Room temperature control via built-in temperature sensor
- 2 configurable inputs temperature or digital
- 2 outputs for on/off and 3-position valve control
- 3 outputs for 1- or 3-speed fan control (automatically or manually)
- Comfort, Economy and Protection operating mode
- Display of current room temperature or temperature set point in °C or °F
- Display of outdoor temperature received from Modbus master
- Manual or automatic heating / cooling changeover
- Select operating mode via operating mode button on the controller
- Minimum and maximum limitation of room temperature set point
- Floor heating temperature limitation
- Key lock function
- RTU Modbus slave interface
- Reload default settings for commissioning and control parameters
- 110...230 VAC operating voltage
- Flush mount on all 75x75x35mm wall mounting box or larger boxes
- Selection of application via parameter
- No data loss on power fail

### 1.2 Safety



#### **DANGER! Safety advice**

This device is for use as an operating controller. It is not a safety device. Where a device failure could endanger human life and property, it is the responsibility of the client, installer and system designer to add additional safety devices to prevent such a device failure. Ignoring specifications and local regulations may cause equipment damage and endanger life and property. Tampering with the device and misapplication will void the warranty.

### 1.3 Types and Ordering

Product Name	Product No.	Description / Type	Size / Length	Weight
<b>Controller</b>				
TRA-F121-A	40-10-0217	Fan coil controller	88 x 88 x 41 mm (3.5 x 3.5 x 1.6 inch)	168g (5.92oz)
<b>Installation box (optional)</b>				
AMB-001	40-51-0009	Flush mounting installation box	80 x 80 x 40 mm (3.2 x 3.2 x 1.6 inch)	40g (1.41oz)
AMB-005	40-51-0010	Surface mounting installation box	85 x 85 x 37 mm (3.4 x 3.4 x 1.5 inch)	46g (1.62oz)
<b>Passive temperature sensor with flying lead (NTC 10kΩ at 25 °C (77 °F))</b>				
S-Tn10-2	40-200001	-	2 m (6 ft.) PVC cable	-
S-Tn10-6	40-200142	-	6 m (19 ft.) PVC cable	-
<b>Passive temperature sensor for duct mounting (NTC 10kΩ at 25 °C (77 °F))</b>				
SD-Tn10-12-2	40-200002	12 cm (4.7 inch) probe	2 m (6 ft.) PVC cable	-
SD-Tn10-20-2	40-200003	20 cm (7.8 inch) probe	2 m (6 ft.) PVC cable	-
SDB-Tn10-12-1	40-200124	12 cm (4.7 inch) probe	-	-
SDB-Tn10-20-1	40-200133	20 cm (7.8 inch) probe	-	-
<b>Passive temperature sensor for contact mounting on pipes (NTC 10kΩ at 25 °C (77 °F))</b>				
SC-Tn10-2	40-200095	-	2 m (6 ft.) PVC cable	-
SC-Tn10-6	40-200159	-	6 m (19 ft.) PVC cable	-
<b>Passive temperature sensor for indoor mounting (NTC 10kΩ at 25 °C (77 °F))</b>				
SRA-Tn10	40-200005	Indoor temperature sensor	88 x 88 x 21 mm (3.5 x 3.5 x 0.8 inch)	-
<b>Passive temperature sensor for outdoor mounting (NTC 10kΩ at 25 °C (77 °F))</b>				
SOD-Tn10-1	40-200108	Outdoor temperature sensor	64 x 64 x 36 mm (2.5 x 2.5 x 1.4 inch)	-



Additional sensors and accessories can be found on the Vector Controls home page [www.vectorcontrols.com](http://www.vectorcontrols.com).

## 2 Technical Specifications

<b>Power supply</b>	Power requirements	110...250 VAC, 50/60 Hz	
	Power consumption	Max. 5 VA	
	Electrical connection	Screw terminals Wire 0.15...2.05 mm <sup>2</sup> (AWG 26...14)	
<b>Built-in sensor</b>	Temperature range	0...50°C (32...122°F)	
	Accuracy 0...50°C	0.5°C (1°F)	
<b>Signal inputs</b>	Digital and temperature input	Selectable via parameter	
	Temperature range	-20...60°C (-4...140°F)	
	Temperature accuracy	0.5°C (1°F) at 0...50°C (32...122°F) 1.0°C (2°F) at <0°C (<32°F), >50°C (>122°F)	
	Type & range of temperature sensor	NTC (Sxx-Tn10): -40...140°C (-40...284°F)	
<b>Signal outputs</b>	Relays outputs	0...250 VAC, resistive load current 5A, inductive 2A	
	Insulation strength between relays and system electronics	2500V to EN 60 730-1	
	Insulation strength between neighboring contacts	2500V to EN 60 730-1	
	Electronic control type	2.B (micro-disconnection)	
<b>Temperature resolution</b>	Displayed temperature	0.1°C (0.5°F)	
	Set point	0.5°C (1°F)	
<b>Network</b>	Hardware interface	RS485 in accordance with EIA/TIA 485	
	Max nodes per network	247	
	Max nodes per segment	128 (TRA-F121-A only)	
	Conductor wire	Shielded Twisted Pair (STP) cable	
	Impedance	100 - 130 Ω	
	Galvanic isolation	The communication circuitry is isolated	
	Network topology	According Modbus manual (Modbus over serial line)	
Recommended maximum length per chain	1200 m (4000 ft.)		
<b>Modbus</b>	Communication standard	Modbus RTU ( <a href="http://www.modbus.org">www.modbus.org</a> )	
	Default setting	38400 baud rate, even parity, 1 stop bit	
	Communication speed (baud rate)	2400, 4800, 9600, 19200, 38400, 57600, 115200	
	Modbus RTU protocol (8 data bits)	no parity – 1 or 2 stop bits; even or odd parity – 1 stop bit	
<b>Environment</b>	Operation	To IEC 721-3-3	
	Climatic conditions	class 3K5	
	Temperature	0...50 °C (32...122 °F)	
	Humidity	<85 % RH non-condensing	
	Transport & storage	To IEC 721-3-2 and IEC 721-3-1	
	Climatic conditions	class 3K3 and class 1K3	
Temperature	-25...70 °C (-13...158 °F)		
Humidity	<95 % RH non-condensing		
Mechanical conditions	class 2M2		
<b>Standards</b>		EMC conformity	2014/30/EU
		Low voltage directive	2014/35/EU
	Automatic electrical controls for household and similar use	EN 60730 – 1	
	Special requirement on temperature dependent controls	EN 60730 – 2 – 9	
	Electromagnetic compatibility for industrial and domestic sector	Emissions: EN 60730-1 Immunity: EN 60730-1	
	Overvoltage category	II (EN 60730-1)	
	Pollution class	II (EN 60730-1)	
	Safety class	II (IEC 61140)	
	Degree of protection	IP30 to EN 60529	
	<b>General</b>	Material	Fire proof PC+ABS plastic (UL94 class V-0)
		Dimensions front part (H x W x D)	88 x 88 x 16 mm (3.5 x 3.5 x 0.6 in)
Dimensions back part (H x W x D)		67 x 61 x 25 mm (2.6 x 2.4 x 1.0 in)	
Weight (including package)		250 g (8.81 oz)	

**2.1 Dimensions, mm (inch)**

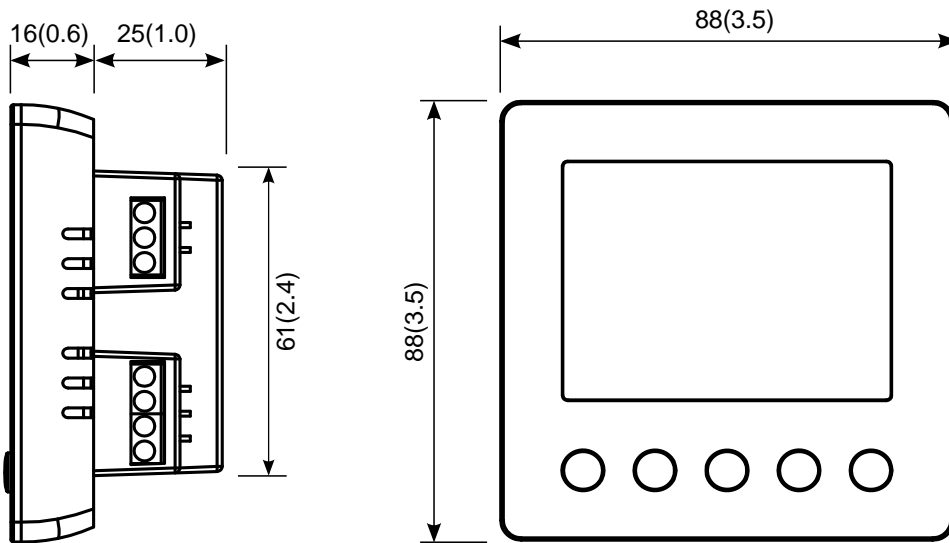

**i** For flush mounting, a 75 x 75 x 35 mm (3.0 x 3.0 x 1,4 inch) installation box or larger must be used. See Ordering for recommended installation boxes (chapter 1.3, page 3).

**2.2 Connection diagram**

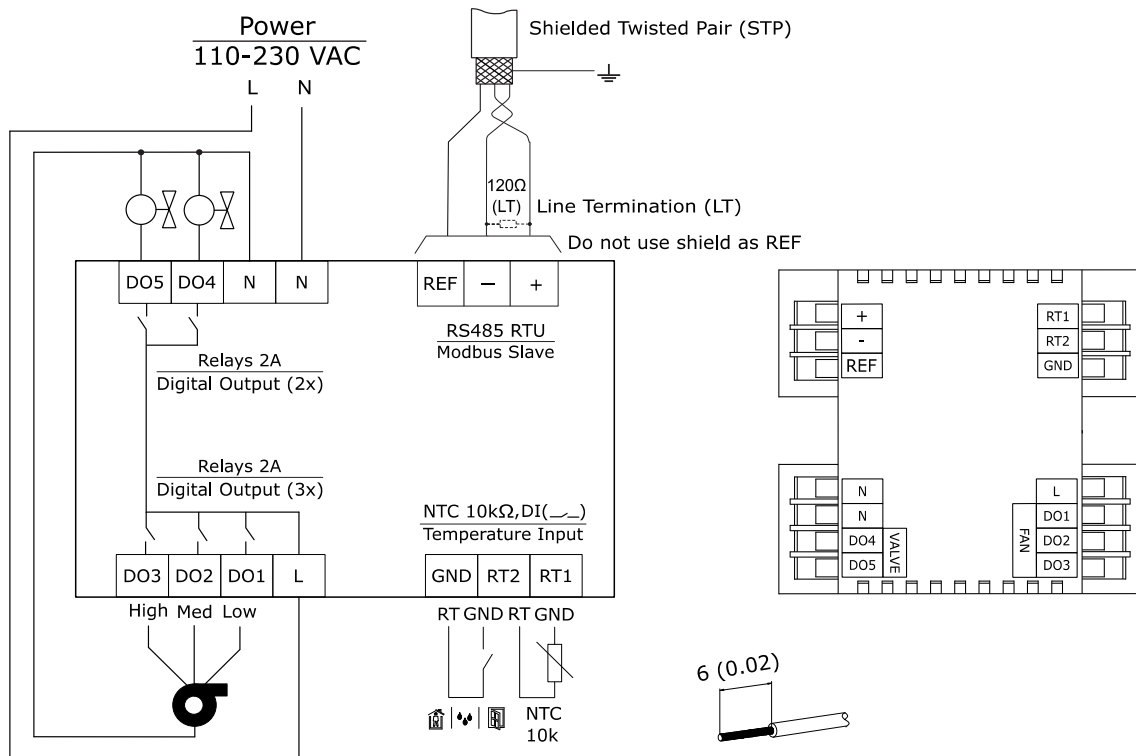

### 3 Operation

#### Content of chapter

3.1	User interface	6
3.1.1	Button operation	6
3.2	LCD Display	7
3.2.1	Operating modes	7
3.2.2	Controlling modes	7
3.2.3	Large and small digits	8
3.2.4	Alarm messages	8
3.2.5	Error messages	8
3.3	Temperature control	8
3.4	Controller operation	9
3.4.1	Operating mode	9
3.4.2	Controlling Mode	9
3.4.3	Temperature control	10
3.4.4	Fan speed	10
3.4.5	Controller start up	10
3.4.6	Power Failure	11
3.5	View input status (RT1/RT2)	11

#### 3.1 User interface

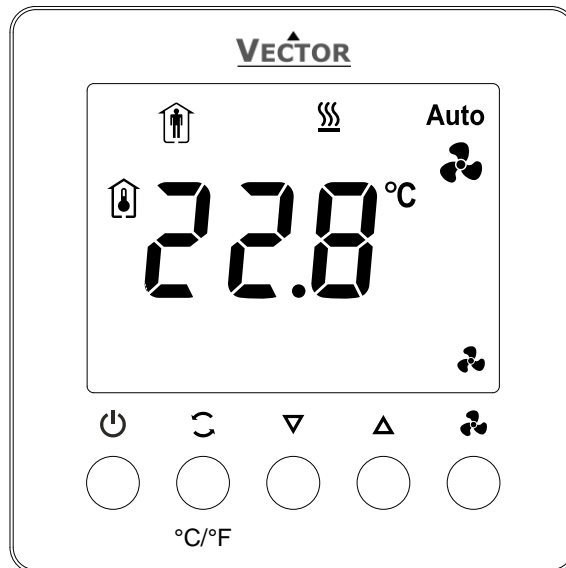

##### 3.1.1 Button operation

Symbol	Function	Description
	Operating mode (Return)	Operating mode selection (Comfort Mode, Economy Mode, Protection Mode) Menu navigation: Return to top menu
	Controlling mode (Return)	Controlling mode selection (Heating Mode, Cooling Mode, Fan Only) Menu navigation: Return to top menu point Long press: Switch °C/°F
	Down (-)	Adjust temperature set points and control parameters
	Up (+)	Adjust temperature set points and control parameters
	Fan (Enter, Save)	Change fan mode (auto mode or fan speed) Menu navigation: Enter menu point Parameter change: Save parameter Long press: Display external input status

**3.2 LCD Display**

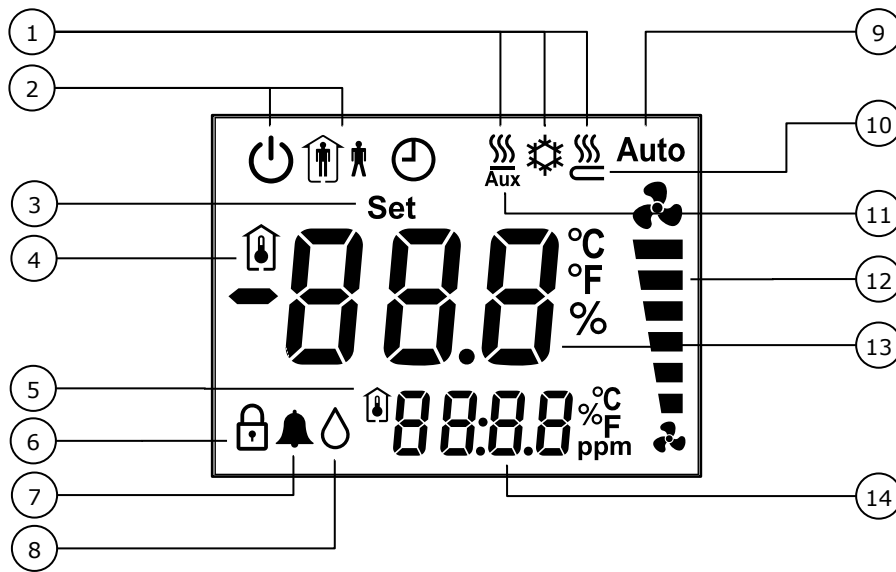

1	Controlling Mode (see chapter 3.2.2)	8	Dew point alarm (see chapter 3.2.4)
2	Operating Mode (see chapter 3.2.1)	9	Fan auto mode
3	Temperature set point or parameter setting active	10	Floor heating
4	Room temperature large digits	11	Electric heater
5	Room temperature small digits	12	Fan speed (low, medium, high)
6	Keys locked	13	Large digits (see chapter 3.2.3)
7	Alarm (see chapter 3.2.4)	14	Small digits (see chapter 3.2.3, 3.2.4, 3.2.5)

**i** ⏻, % and ppm not used.

**3.2.1 Operating modes**

Display	Mode	Description
	Comfort (occupied)	The controller maintains the Comfort temperature set point defined with parameter P300. In Comfort mode, the fan can be set to auto or manual fan speed: Low, medium or high.
	Economy (unoccupied)	Controller maintains the Economy temperature set points defined with parameter P301 and P302.
	Protection	The controller runs in standby. The system is protected against overheating and frost if enabled with parameter P303 and P304.

**3.2.2 Controlling modes**

Display	Mode	Description
	Heating	Heating mode activates heater for temperatures below set point. When the heating symbol is blinking, the heating valve is turned on. Also, the electric heater or floor heating symbols are blinking if the heating valve is turned on.
	Cooling	Cooling mode activates cooling equipment for temperatures above the set point. When the cooling symbol is blinking the cooling valve is turned on.
	Fan Only	The bars between the fan symbols show the fan speed (low, medium, high).

### 3.2.3 Large and small digits





The large digits show the measured room temperature (default setting) or the Comfort temperature set point (configurable via parameter P101).

The small digits are off (default setting) or show the outdoor temperature from Modbus master (configurable via parameter P101). Also, alarms and error messages are shown on the small digits.

The room temperature and temperature set point are given in °C or °F (according to parameter P102).

### 3.2.4 Alarm messages

Alarm messages with alarm symbol are shown on the small digits.

Small Digits	LCD symbol	Alarm condition
ALA1		Alarm
		Dew point
ALA2		Overheat protection alarm (only in Protection mode)
ALA3		Frost protection alarm (only in Protection mode)

### 3.2.5 Error messages

Error messages are shown on the small digits.

Small Digits	Error condition
Err1	Built-in temperature sensor error. Sensor is damaged (open or short circuit).
Err2	Temperature sensor RT1/RT2 error. The temperature sensor is not present. Verify wiring or parameter configuration. -99.9 is shown on large digits.
Err3	Digital input error. RT1/2 is not fully opened or closed (resistor between 2.5kΩ and 350kΩ). Verify wiring or parameter configuration.
Err4	Configuration error: A parameter is set in an invalid combination with another parameter. Err4 and one of the conflicting parameters are displayed alternating.
Err5	Time error: Set time and acknowledge error.

## 3.3 Temperature control

The thermostat measures the room temperature via built-in sensor or external room temperature sensor and maintains the set point temperature by controlling the fan speeds and the heating and/or cooling valve (or the electric heater). The following control outputs are available:

- on/off valve
- 3-position valve (only for 2-pipe systems)

The switching differential or proportional band is 2°C for heating mode and 1°C for cooling mode (configurable via parameters P400 and P401).

The integral time is 5 minutes (adjustable via parameter P402 with 300 seconds as default value).



### 3.4 Controller operation

**i** Enable or disable of economy mode and change of set point, fan speed, controlling mode or any user operation can be done via parameter settings (see parameter P104 to P108, default is ON and key lock disabled).

#### 3.4.1 Operating mode

The controller operating mode can be switched between **Comfort** and **Economy Mode** with the operating mode button (⏻).

The controller is switched to **Protection Mode** by pressing the operating mode button (⏻) for 2 seconds.

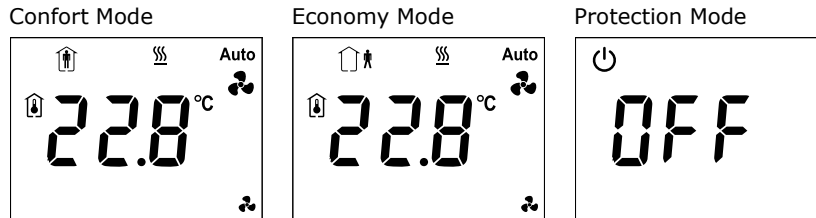

**i** If Economy mode is disabled (see parameter P103), the controller operating mode is switched between Comfort and Protection mode with the operating mode button (⏻).

#### Comfort Mode

In Comfort mode, the controller measures the room temperature via built-in sensor or external room temperature sensor and maintains the temperature of the Comfort set point by controlling the fan speeds and the heating and/or cooling valve (or the electric heater).

#### Economy Mode

In Economy mode, the controller measures the room temperature via built-in sensor or external room temperature sensor and maintains the temperature of the Economy set point by controlling the fan speeds and the heating and/or cooling valve (or the electric heater).

The temperature of the Economy set point depends on the controller configuration (see parameter P301 and P302).

#### Protection Mode

In Protection mode, the system is protected against frost (default 5 °C, see parameter P304) and protected against overheating (default OFF) (see parameter P303).

#### 3.4.2 Controlling Mode

The controlling mode of the controller can be switched between **Heating Mode**, **Cooling Mode** and **Fan Only** by pressing the controlling mode button (↻).

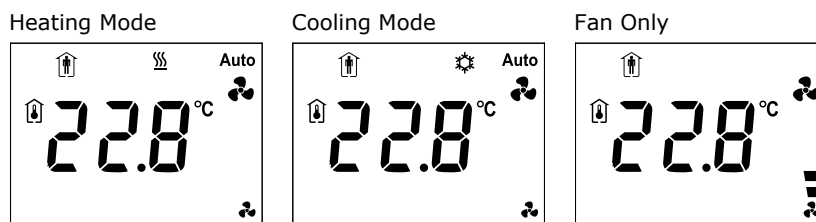

**i** Depending on the configured application (see parameter P200), cooling or heating can't be selected as controlling mode.

#### Heating Mode

In heating mode, the controller measures the room temperature via built-in sensor or external room temperature sensor and maintains the requested temperature (according to the Operating Mode Comfort, Economy or manual setting), by controlling the fan speeds and the heating valve (or the electric heater).

#### Cooling Mode

In cooling mode, the controller measures the room temperature via built-in sensor or external room temperature sensor and maintains the requested temperature (according to the Operating Mode Comfort, Economy or manual setting), by controlling the fan speeds and the cooling valve.

**Fan Only** 

In fan only mode, the fan speed can be set with the up ( $\Delta$ ) or down ( $\nabla$ ) button. Heating or cooling is deactivated.

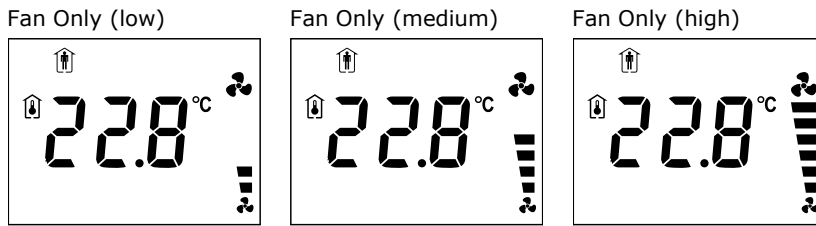

**3.4.3 Temperature control**

The comfort temperature set point can be adjusted in 0.5°C (1°F) steps with the up ( $\Delta$ ) and down ( $\nabla$ ) button and saved either with the operating mode button ( $\text{⏻}$ ), the controlling mode button ( $\text{⌚}$ ) or the fan button ( $\text{⚙}$ ). The Set symbol is shown on the display while changing the temperature.

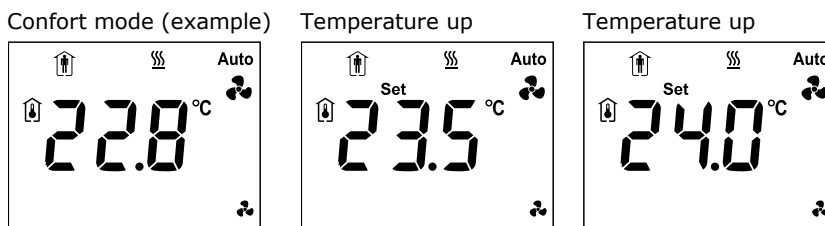

If the Economy mode is active, pressing the up ( $\Delta$ ) or down ( $\nabla$ ) button will change the controller into the comfort mode.

**3.4.4 Fan speed**

The fan speed can be changed between auto, low, medium and high fan speed by pressing the fan button ( $\text{⚙}$ ).

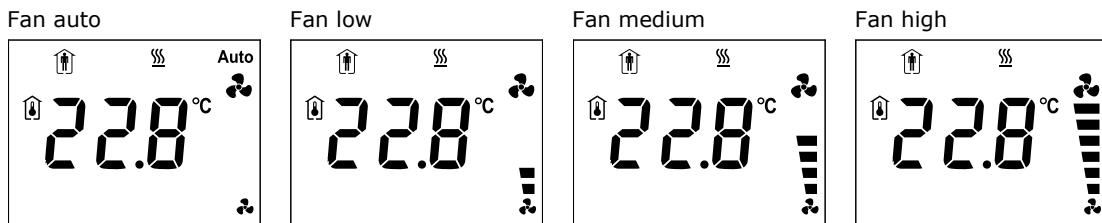

**3.4.5 Controller start up**

**Normal start-up**

During start-up, the backlight of the display and all LCD segments are shown for two seconds. Then the software version and revision are shown for two seconds on the small digits (format: 1r0, means version 1 revision 0). Then the Modbus address of the controller is shown for two seconds.

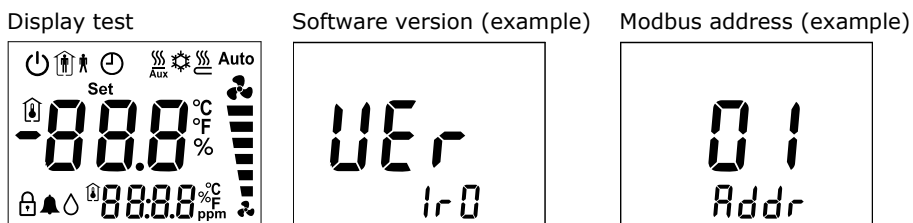

**Start-up with Modbus address not set (after initial installation)**

During start-up, the backlight of the display and all LCD segments are shown for two seconds. Then the software version and revision are shown for two seconds on the small digits (format: 1r0, means version 1 revision 0).

After the software version, the Modbus address can be set with the up (▲) or down (▼) button and stored with the fan button (🌀).

You can leave the set menu without saving the Modbus address by pressing the operating (⏻) or controlling (⌚) mode button.

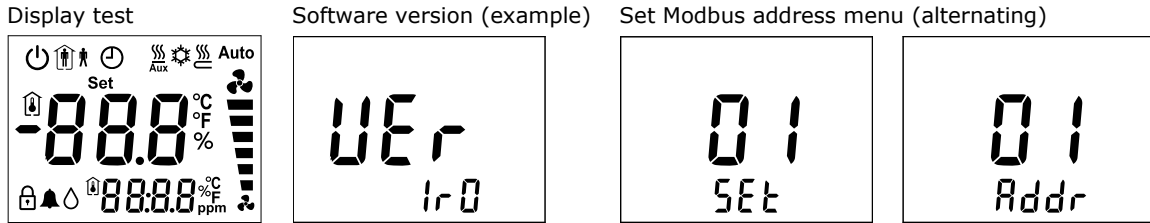

**i** If no address is entered, set mode is left automatically after 10 minutes. The address set menu will appear again on the next start-up.

After these steps the controller runs in comfort, economy or protection mode.

**3.4.6 Power Failure**

All temperature set points and parameters are automatically saved and do not need to be re-entered.

Upon return of power, the controller will start in Protection, Comfort or the same mode, according to the controller configuration (see parameter P110).

**3.5 View input status (RT1/RT2)**

Press the fan button (🌀) for minimum 3 seconds to enter the input menu. The input status of RT1 and RT2 is displayed in alternation.

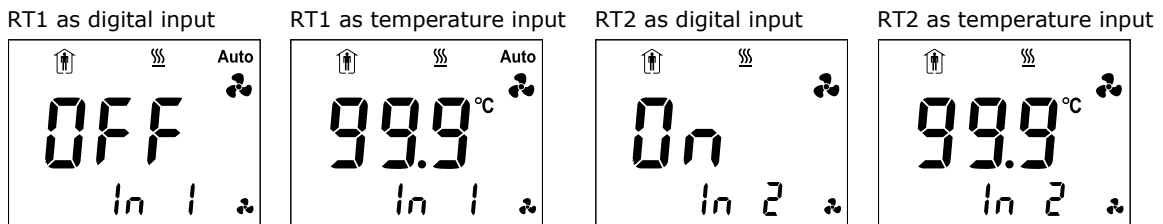

The status of the inputs is displayed:

Large Digits	Small digits	Condition
on/off	In 1	RT1 configured as NO/NC digital input
Temperature in °C/°F	In 1	RT1 configured as NTC temperature sensor
on/off	In 2	RT2 configured as NO/NC digital input
Temperature in °C/°F	In 2	RT2 configured as NTC temperature sensor

Press the Operating (⏻) or Controlling (⌚) Mode button to leave the menu. After one minute the input menu is left automatically.

## 4 Setting up the controller

### 4.1 Mounting and installation

See TRA-F121-A installation sheet no. 70-000791 ([www.vectorcontrols.com](http://www.vectorcontrols.com)).

### 4.2 Selection of actuators and sensors

#### Temperature sensors:

Use Vector Controls NTC sensors to achieve maximum accuracy, see ordering list in chapter 1.3, page 3.

#### Binary auxiliary devices (e.g. fans, on/off valves, etc.):

Do not directly connect devices that exceed specified limits in technical specifications – observe startup current on inductive loads.

### 4.3 Electrical connection of external inputs

Use only twisted pair copper conductors for input connections. The operating voltage must comply with the requirements for safety extra-low voltage (SELV) as per EN 60 730.

### 4.4 Power Failure

All temperature set points and parameters are automatically saved and do not need to be re-entered.

### 4.5 Modbus wiring

#### 4.5.1 Wire type

An EIA-485 network shall use shielded, twisted-pair cable for data signaling with characteristic impedance between 100 and 130Ω s. Distributed capacitance between conductors shall be less than 100 pF per meter (30 pF per foot). Distributed capacitance between conductors and shield shall be less than 200 pF per meter (60 pF per foot). Foil or braided shields are acceptable.

#### 4.5.2 Line termination

On last node on either end of the bus connect a 120Ω termination resistor between (+) and (-).

#### 4.5.3 Maximum length

The maximum recommended length per segment is 1200 meters (4000 feet) with AWG 18 (0.82 mm<sup>2</sup>) conductor area cable.

#### 4.5.4 Shield connection

See Ashrae Standard 135 for detailed recommendation regarding how to connect the shield depending on type of nodes present in the network.

#### 4.5.5 Communication wiring

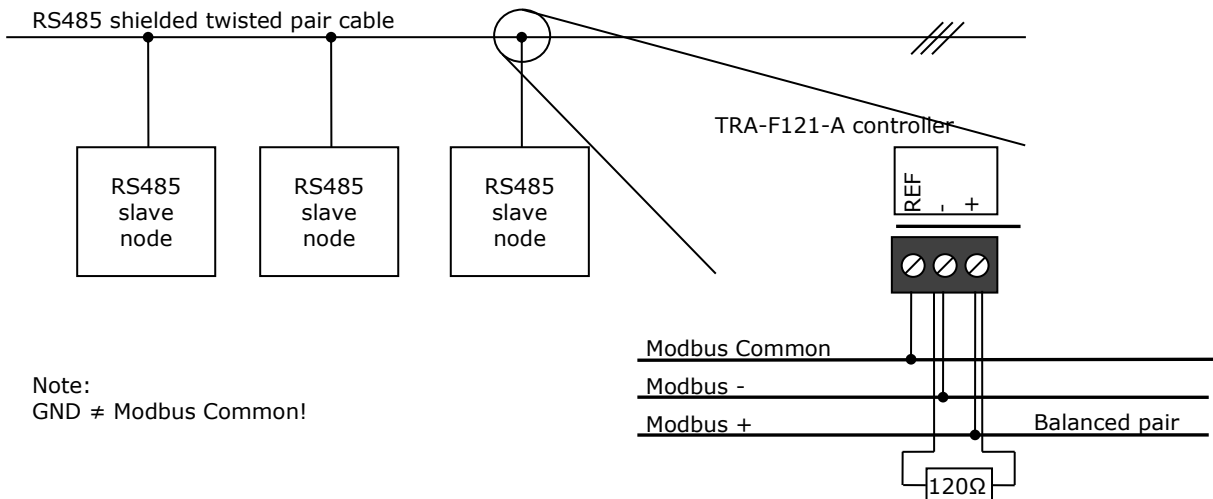

On last node on either end of bus only:  
 Connect 120Ω termination resistor between Modbus - and Modbus +.

## 5 Configuration (parameter options)

### Content of chapter

5.1	Parameter usage	13
5.1.1	Parameter number, resolution and data format	13
5.1.2	Modbus access	13
5.2	Setting controller parameter with user interface	14
5.3	Modbus settings	14
5.3.1	Parameter P00x overview	14
5.4	Operating options	15
5.4.1	Parameter P1xx overview	15
5.5	Quick system and output configuration (application specific)	16
5.5.1	Parameter P000 overview	16
5.5.2	Application modes: Wiring diagrams of outputs	16
5.6	System and output configuration	17
5.6.1	Parameter P2xx overview	17
5.6.2	Application modes: Valve control diagrams	18
5.6.3	Application modes: Wiring diagrams of outputs	19
5.6.4	Manual vs. auto heat/cool change	20
5.6.5	3-position valve control	20
5.6.6	Fan extension time for electric heater	20
5.6.7	Periodic fan kick	20
5.6.8	Floor heating system with or without floor temperature limitation	21
5.7	Set points	22
5.7.1	Parameter 3xx overview	22
5.7.2	Temperature set point types	22
5.8	Control settings	24
5.8.1	Parameter 4xx overview	24
5.8.2	Proportional control (proportional band or switching differential)	24
5.8.3	Integral control (integral time)	24
5.8.4	on/off control	24
5.8.5	on/off control for 4-pipe application heating and cooling mode	25
5.8.6	3-position control	25
5.8.7	Fan control in automatic mode (on/off control)	26
5.8.8	Fan control in automatic mode (3-position control)	26
5.9	Temperature and digital inputs	27
5.9.1	Parameter P5xx overview	27
5.9.2	P500/502: 2 = Heat/cool changeover or floor temperature sensor (NTC or DI)	27
5.9.3	P500: 5 = Door switch (DI) and P502: 3 or 4 = Occupation sensor (DI)	28
5.9.4	P500/502: 7 = Dew point sensor	28
5.9.5	P500/502 digital input assignment	28
5.10	Load and store default settings	29
5.10.1	With user interface	29
5.10.2	With Modbus	29

### 5.1 Parameter usage

#### 5.1.1 Parameter number, resolution and data format

Parameter number and Modbus data address are the same. They are listed in column "Par/Addr" as decimal number. E.g. P001 is parameter 001 and has Modbus data address 1.

All temperature related parameters are given in °C for Modbus. Only in the user interface values can be shown in °F. Parameters without multiplier have a resolution of 1. Parameters with multiplier 10 have a resolution of 0.1. For example, the default value of the Comfort temperature set point (P300) is 20.0°C and the value read via Modbus is 200 (because multiplier 10 is used for P300).

The multiplier is only used for Modbus data access. On the user interface, the values are displayed in normal resolution. Parameter with values below 0 (zero) are given as signed integer values.

#### 5.1.2 Modbus access

The controller supports the following Modbus function codes:

Modbus function code	Data
Read multiple register (0x03)	Read n registers (n x 2 bytes) starting from requested address.
Write register (0x06)	Write 1 register (2 bytes) at requested address.
Write multiple registers (0x16)	Write n register (n x 2 bytes) starting from sent address.

Note: The read/write capability of each parameter is defined in column "R/W". Most parameters can be read and written defined as "R/W". Read only parameters are defined as "R".

## 5.2 Setting controller parameter with user interface

### Entering the password protected parameter menu

1. Press the up ( $\Delta$ ) and down ( $\nabla$ ) button for at least 3 seconds.
2. The software version is displayed.
3. To continue to the password menu, press either the up ( $\Delta$ ), down ( $\nabla$ ) or fan button ( $\clubsuit$ ).
4. Enter the code **241** with the up ( $\Delta$ ) or down ( $\nabla$ ) button.
5. Confirm the code with the fan button ( $\clubsuit$ ).

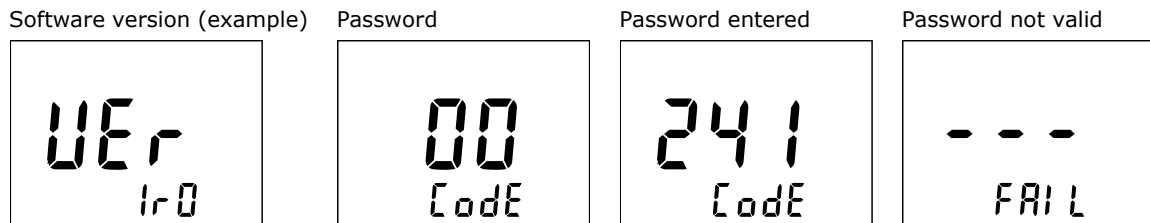

### Setting parameters

1. Press the up ( $\Delta$ ) or down ( $\nabla$ ) button to select the desired parameter.
2. To set the value of parameter, press the fan button ( $\clubsuit$ ) then adjust the value with the up ( $\Delta$ ) or down ( $\nabla$ ) button and save the setting by pressing the fan button ( $\clubsuit$ ) again.

### Exit the parameter menu

Press the Operating ( $\text{⏻}$ ) or Controlling ( $\text{⏸}$ ) Mode button to leave the parameter menu.

## 5.3 Modbus settings

### 5.3.1 Parameter P00x overview

Each Modbus slave device needs a unique device address (ID) in the network. It can be set with P001. All other Modbus network properties can be set with parameter P002, P003 and P006.

With parameter P005 the write access to the parameter via Modbus master is disabled (except P005 can always be written).

P004 is not used.

Par/ Addr	Description	Data type / value	Default	R/W
P001	Modbus device address (ID)	Address range: 1...247	1	R/W
P002	Baud Rate Modbus RS485	0 = 2400 BPS 1 = 4800 BPS 2 = 9600 BPS 3 = 19200 BPS 4 = 38400 BPS 5 = 57600 BPS 6 = 115200 BPS	4	R/W
P003	Parity and stop bits	0 = NO Parity, 2 stop bits 1 = EVEN Parity, 1 stop bit 2 = ODD Parity, 1 stop bit 3 = NO Parity, 1 stop bit	1	R/W
P004	Mode of communication	Not used (always 1 = RTU)	1	R
P005	Allow changing of parameter settings through communication	0 = Not allowed (except P005) 1 = Allowed	1	R/W
P006	Modbus address PLC style	0 = No offset 1 = PLC address style (+1 address offset)	0	R/W

## 5.4 Operating options

### 5.4.1 Parameter P1xx overview

With parameter P100 – P102 the displayed content can be set.

With parameter P104 – P109 the access via user interface can be restricted.

With P103 the Economy mode can be disabled (default is enabled).

With P110 the controller state after power failure can be set.



When P102 is set to °F, only the user interface values are displayed in °F. The values in the parameter menu are always in °C.

Par/ Addr	Description	Data type / value	Default	R/W
P100	Standard temperature display (large digits)	0 = Room temperature (built-in sensor or external NTC on RT1/2) 1 = Set point of running operating mode	0	R/W
P101	Display on small digits	0 = No display 1 = Outdoor temperature (via Modbus)	0	R/W
P102	Selection of temperature unit	0 = °C 1 = °F	0	R/W
P103	Enable Economy mode	0 = OFF = Economy mode disabled 1 = ON = Economy mode enabled	1 = ON	R/W
P104	Enable temperature unit change with button (long press)	0 = OFF = Changing disabled 1 = ON = Changing enabled	1 = ON	R/W
P105	Enable change of temperature set points via user interface	0 = OFF = Change of set points disabled 1 = ON = Change of set points enabled	1 = ON	R/W
P106	Enable manual control of fan speeds via user interface	0 = OFF = Manual control of fan speeds via user interface disabled 1 = ON = Manual control of fan speeds via user interface enabled	1 = ON	R/W
P107	Enable manual control of heat/cool/fan only via user interface	0 = OFF = Manual control of heat/cool/fan only disabled 1 = ON = Manual control of heat/cool/fan only enabled	1 = ON	R/W
P108	Key lock (No button operation)	0 = Disabled 1 = Keys locked 2 = Manual lock (Press 5 sec Up (▲) and Down (▼) button, then 5 sec Operating (⏻) and Controlling Mode buttons (↻) to unlock. After 5min without user action the buttons are locked again.)	0	R/W
P109	Enable all parameter for user interface (P001 to P506)	0 = Disable (parameter can only be changed from Modbus master) 1 = Enable (parameter can be changed from user interface)	1	R/W
P110	State after power failure	0 = Protection mode (OFF) 1 = Comfort mode (ON) 2 = State before power failure	2	R/W

## 5.5 Quick system and output configuration (application specific)

A set of predefined system and output parameters allows for easy selection of a typical TRA application.

With P000, it is possible to select from a set of predefined configurations.

Using a predefined configuration will override some of the affected P200, P201 and P203 parameters accordingly.

If one of the preset P200, P201 or P203 parameters is changed, P000 will be reset to 0.

Par/ Addr	Description	Data type / value	Default	R/ W
P000	Use a predefined application configuration	Range: 0...17	0	R/ W

### 5.5.1 Parameter P000 overview

The following predefined system configurations are available:

P000 value	Description of predefined system configurations (application)
0	Default TRA application
1	2-pipe heating only, on/off valve, 3 stage fan
2	2-pipe cooling only, on/off valve, 3 stage fan
3	2-pipe manual heating or cooling, on/off valve, 3 stage fan
4	2-pipe automatic heating or cooling, on/off valve, 3 stage fan, changeover sensor at RT1
5	2-pipe heating only, 3-point valve, 3 stage fan
6	2-pipe cooling only, 3-point valve, 3 stage fan
7	2-pipe manual heating or cooling, 3-point valve, 3 stage fan
8	2-pipe automatic heating or cooling, 3-point valve, 3 stage fan, changeover sensor at RT1
9	2-pipe cooling only with electric heater, on/off valve, 3 stage fan
10	4-pipe manual heating or cooling, on/off valve, 3 stage fan
11	4-pipe auto heating or cooling, 3 stage fan, RT1 as digital changeover input (NO)
12	4-pipe heating and cooling, 3 stage fan
13	Floor heating, on/off valve
14	Floor heating, 3-point valve
15	Chilled ceiling, 3-point valve
16	Chilled ceiling, on/off valve
17	Chilled ceiling, on/off valve, electric heater



Depending on the desired functionality of the TRA control, additional configuration may be required.



A detailed description of the system and output configuration can be found in chapter 5.6 System and output configuration, page 17.

### 5.5.2 Application modes: Wiring diagrams of outputs



An overview of the of the application specific output wiring diagrams can be found in chapter 5.6.3, page 19.



## 5.6 System and output configuration

### 5.6.1 Parameter P2xx overview

With parameter P200 – P203 the installed application and valve type can be selected.

With parameter P204 – P206 the valve characteristics can be set.

With parameter P207 – P214 the fan configuration can be set.

Par/ Addr	Description	Data type / value	Default	R/ W
P200	Application mode: 2-pipe system: 0...3 4-pipe system: 4...6	0 = Heating only 1 = Cooling only 2 = 2-pipe manual heating or cooling 3 = 2-pipe auto heat/cool changeover 4 = 4-pipe manual heating or cooling 5 = 4-pipe auto heat/cool changeover 6 = 4-pipe Heating and cooling 7 = Floor heating system 8 = Chilled ceiling system	0	R/ W
P201	Enable electric heater	0 = OFF = Electric heater disabled 1 = ON = Electric heater enabled	0 = OFF	R/ W
P202	Not used	-	-	-
P203	Valve type of heating/cooling system	0 = on/off valve 1 = 3-position valve (only for 2-pipe systems)	0	R/ W
P204	3-position valve running time	20...500 sec	150 sec	R/ W
P205	Minimum on time of valve for on/off type	1...30 min	1 min	R/ W
P206	Minimum off time of valve for on/off type	1...30 min	1 min	R/ W
P207	Number of fan speeds	1 = 1 fan speed (only DO1) 3 = 3 fan speeds	3	R/ W
P208	Minimum on time of each fan speed	10...600 sec	120 sec	R/ W
P209	Low fan speed switch on level (Switch off level 15% lower or 0%) Note: Ignored for on/off valve (and electric heater), see chapter 5.8 Control settings	0...25 %	10 %	R/ W
P210	Medium fan speed switching point (Switch off level 15% lower)	30...75 %	60 %	R/ W
P211	High fan speed switching point (Switch off level 15% lower)	80...100%	100 %	R/ W
P212	Fan kick period	0 = OFF = Fan kick disabled 5...1500 = period in minutes	0 = OFF	R/ W
P213	Minimum fan speed in auto mode	0 = Fan off 1 = Low speed	0	R/ W
P214	Minimum fan speed in manual mode	0 = Fan off 1 = Low speed	1	R/ W

### 5.6.2 Application modes: Valve control diagrams

Detailed explanation of Comfort and Economy temperature set points are given in chapter 5.7 Set points, page 22.

Detailed explanation of on/off or 3-position valve control are given in chapter 5.8 Control settings, page 24.

Detailed explanation of auto heat/cool changeover are given in chapter 5.9 Temperature and digital inputs, page 27.

Affected Parameters	Parameter Description
P200	Application mode

Application mode	P200 setting	Valve control diagram (comfort mode)
2-pipe system Heating only	0	<p>W: Comfort set point</p>
Floor heating system	7	
2-pipe system Cooling only	1	
Chilled ceiling system	8	
2-pipe system manual heating or cooling	2	
4-pipe system manual heating or cooling	4	
2-pipe system auto heat/cool changeover	3	
4-pipe system auto heat/cool changeover	5	
4-pipe system Heating and cooling	6	

5.6.3 Application modes: Wiring diagrams of outputs

Affected Parameters	Parameter Description
P200	Application mode
P201	Enable electric heater
P203	Valve type of heating/cooling system

System	P000 predefined settings	P200, P201, P203 settings	Wiring diagram of outputs
<ul style="list-style-type: none"> <li>2-pipe system</li> <li>on/off valve</li> <li>DO4: Heating or cooling</li> </ul>	1 = Heating only 3-stage fan  2 = Cooling only 3-stage fan  3 = Manual heating or cooling 3-stage fan  4 = Automatic heating or cooling 3-stage fan	P200 0, 1, 2 or 3 P201 0 = OFF P203 0 = on/off valve	
<ul style="list-style-type: none"> <li>2-pipe system</li> <li>3-position valve</li> <li>Heating or cooling</li> <li>DO4 open valve</li> <li>DO5 close valve</li> </ul>	5 = Heating only 3-stage fan  6 = Cooling only 3-stage fan  7 = Manual heating or cooling 3-stage fan  8 = Automatic heating or cooling 3-stage fan	P200 0, 1, 2 or 3 P201 0 = OFF P203 1 = 3-position valve	
<ul style="list-style-type: none"> <li>2-pipe system cooling only with electric heater</li> <li>on/off cooling valve</li> <li>DO4: Cooling</li> <li>DO5: Electric Heater</li> </ul>	9 = Cooling with electric heater 3-stage fan	P200 1 = Cooling only P201 1 = ON = Electric heater enabled P203 0 = on/off valve	
<ul style="list-style-type: none"> <li>4 pipe system</li> <li>on/off valve</li> <li>Heating and/or cooling</li> <li>DO4: Cooling</li> <li>DO5: Heating</li> </ul>	10 = Manual heating or cooling 3-stage fan  11 = Auto heating or cooling RT1 as normally open DI 3-stage fan  12 = Heating and cooling 3-stage fan	P200 4, 5 or 6 P201 0 = OFF P203 0 = on/off valve	
<ul style="list-style-type: none"> <li>Floor heating system</li> <li>on/off valve</li> <li>DO4: Heating</li> </ul>	13 = Floor heating On/off valve	P200 7 = Floor heating system P201 0 = OFF P203 0 = on/off valve	

System	P000 predefined settings	P200, P201, P203 settings	Wiring diagram of outputs
<ul style="list-style-type: none"> <li>Floor heating / chilled ceiling system</li> <li>3-position valve</li> <li>DO4 open valve</li> <li>DO5 close valve</li> </ul>	14 = Floor heating 3-point valve  15 = Chilled ceiling 3-point valve	P200 7 or 9 P201 0 = OFF P203 1 = 3-position valve	
<ul style="list-style-type: none"> <li>Chilled ceiling system</li> <li>DO4: Cooling</li> <li>DO5: Electric heater (optional)</li> </ul>	16 = Chilled ceiling On/off valve 17 = Chilled ceiling On/off valve Electric heater	P200 8 = Chilled ceiling system P201 0 or 1 (optional electric heater) P203 0 = on/off valve	

#### 5.6.4 Manual vs. auto heat/cool change

Manual heating or cooling allows the user interface (via Controlling Mode button ) and Modbus master to change between heating and cooling. No input (RT1/2) can use the function "Heat/cool changeover" (P400/P402 = 2).

To allow only Modbus master control the heat/cool state parameter, P107(Enable manual control of heat/cool/fan only) must be set to 0 = OFF. Modbus master can control the Controlling mode (heat/cool/fan only) with controller runtime data D1101.

Auto heat/cool changeover allows one of the inputs (RT1/2, where RT1 has higher priority) to act as a control input for heat/cool changeover. See chapter 5.9 Temperature and digital inputs, page 27. User interface and Modbus master control of heat/cool change are disabled in auto heat/cool application (P200 = 3 or 5). Via user interface the user can only change to fan only.

#### 5.6.5 3-position valve control

Output DO4 the OPEN command, output DO5 provides the CLOSE command to the 3-position valve. The default setting for the valve running time is 150 seconds. It can be adjusted via parameter P204.

##### Valve synchronization:

- After power up the CLOSE command (DO5) is on for two times the valve running time (P204).
- When the control output is <5%, the CLOSE command (DO5) is on for an additional valve running time.
- When the control output is >95%, the OPEN command (DO4) is on for an additional valve running time.

#### 5.6.6 Fan extension time for electric heater

When the electric heater is switched off, the fan keeps running for 1 minute to avoid over-heating of the electric heater.

#### 5.6.7 Periodic fan kick

The periodic fan kick is disabled by default settings.

In automatic fan mode, if the fan speed is 0, the fan will be set to fan speed 1 periodically with the time defined with P212. The fan runs after this period for the minimum on time for fan speeds (P208).

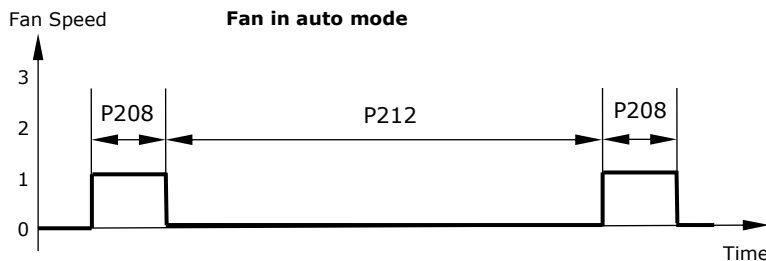

**5.6.8 Floor heating system with or without floor temperature limitation**

Detailed explanation of floor temperature limitation is given in chapter 5.9 Temperature and digital inputs, page 27.

The floor heating system can be configured with or without floor temperature limitation.

<b>Parameter setting...</b>	<b>with floor temperature limitation</b>	<b>without floor temperature limitation</b>
P200 (Application Mode)	7 = Floor heating system	7 = Floor heating system
P500/P502 (Input RT1/RT2 Configuration)	2 = Heat/cool changeover or floor temperature sensor (NTC or DI)	Not 2 (0 - 1, 3 - 7)
P501/P503 (Definition of RT1/ RT2)	0 = NTC temperature sensor	X
P505 (Floor temperature limit)	Set limitation (Default: 30°C/86°F)	Ignored

## 5.7 Set points

### 5.7.1 Parameter 3xx overview

Par/ Addr	Description	Data type / value	Default	R/ W
P300	Comfort temperature set point	Multiplier: 10 10.0...40.0 °C (50.0...104.0 °F)	20.0 °C (68.0 °F)	R/ W
P301	Economy temperature set point in Heating mode Heating temperature set point < Cooling temperature set point	Multiplier: 10 10.0...25.0 °C	15.0 °C	R/ W
P302	Economy temperature set point in Cooling mode Cooling temperature set point > Heating set point	Multiplier: 10 20.0...40.0 °C	30.0 °C	R/ W
P303	Overheat protection temperature point	Multiplier: 10; Integer (signed) 25.0...45.0 °C -0.1 = OFF	-0.1 = OFF	R/ W
P304	Frost protection temperature point	Multiplier: 10; Integer (signed) 0.0...16.0 °C -0.1 = OFF	5.0 °C	R/ W
P305	Minimum temperature set point limit in heating mode	Multiplier: 10 10.0...40.0 °C	16.0 °C	R/ W
P306	Maximum temperature set point limit in heating mode	Multiplier: 10 10.0...40.0 °C	30.0 °C	R/ W
P307	Minimum temperature set point limit in cooling mode	Multiplier: 10 10.0...40.0 °C	14.0 °C	R/ W
P308	Maximum temperature set point limit in cooling mode	Multiplier: 10 10.0...40.0 °C	28.0 °C	R/ W

### 5.7.2 Temperature set point types

There are several temperature set points with different functionalities.

The default temperature set point is the Comfort set point P300. This set point may be directly changed by the user on the user interface. It is active during Comfort Mode.

In Economy mode the economy temperature set point is active (economy heating set point P301 in heating mode and economy cooling set point P302 in cooling mode).

For protection of the facility, overheat protection temperature set point P303 and frost protection temperature set point P304 can be defined. In default settings, overheat protection is disabled.

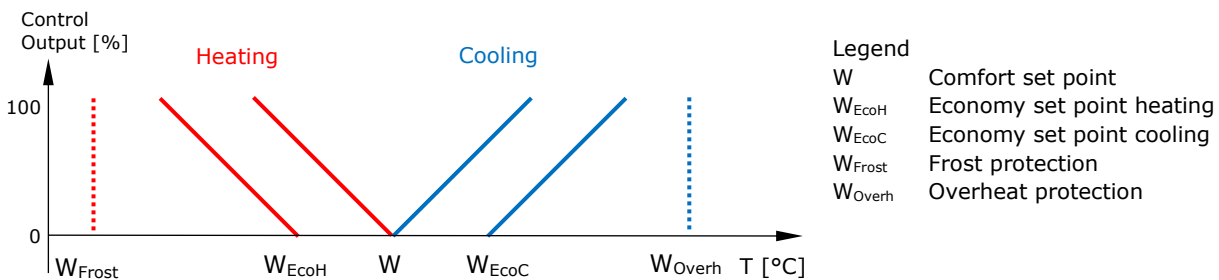

Note 1: If enabled, frost protection and overheat protection are only active in Protection mode.

Note 2: Comfort set point is not compared with economy heating/cooling set point, nor with frost/overheat protection set points. Economy set points are not compared with frost/overheat protection set points.

Application	Comfort mode		Economy mode	
	Heating	Cooling	Heating	Cooling
2-pipe system Heat only, Cool only, Heat or cool (P200 = 0, 1, 2, 3)				
4-pipe system Heat or cool (P200 = 4, 5)				
4-pipe system Heat and cool (P200 = 6)				

The controller acquires the room temperature via built-in sensor or external temperature sensor and maintains the temperature set point by delivering actuator control commands to heating and/or cooling equipment.

## 5.8 Control settings

### 5.8.1 Parameter 4xx overview

Par/ Addr	Description	Data type / value	Default	R/ W
P400	<b>Heating mode</b> on/off valve: Switching differential ( $X_H$ ) 3-position valve: Proportional band ( $X_{pH}$ ) See P203 for valve type	Multiplier: 10 0.1...10.0 °C	2.0 °C	R/ W
P401	<b>Cooling mode</b> on/off valve: Switching differential ( $X_C$ ) 3-position valve: Proportional band ( $X_{pC}$ ) See P203 for valve type	Multiplier: 10 0.1...10.0 °C	1.0 °C	R/ W
P402	Integral time Note: For floor heating and chilled ceiling the integral action is 60 times slower	0 = Integral disabled 10 ... 1200 sec Floor heating: 10 ... 1200 min	300 sec Floor h.: 60 min	R/ W
P403	Dead zone half span (in Comfort mode for cooling and heating application [P200 = 6])	Multiplier: 10 0.1...5.0 °C	1.0 °C	R/ W

### 5.8.2 Proportional control (proportional band or switching differential)

The proportional control function calculates the output based on the difference between temperature set point and measured room temperature. The proportional band (P-band) defines the difference between temperature set point and input required to produce a 100% output. For example: a heating control sequence and a 2.0 °C P-band value will produce a 100% output when the input temperature is 2.0 °C below temperature set point.

Proportional band (P-band) is the inverted proportional gain. Small P-band values lead to a fast reacting controller (susceptible for oscillation). Large P-band values lead to a slow reacting controller.

### 5.8.3 Integral control (integral time)

The integral time is the time required to obtain the same manipulated variable as for the proportional action when using only an integral action. The shorter the integral time, the stronger the correction is of the integral action.

$$out(t) = \frac{1}{X_{H/C}} \left( e(t) + \frac{1}{T_I} \int_0^t e(\tau) d\tau \right)$$

$$out(t) = \text{Control Output (heat or cool)}$$

$$e(t) = \text{setpoint}(t) - \text{temperature}(t)$$

$$X_{H/C} = \text{proportional band or switching differential (heat or cool)}$$

$$T_I = \text{integral time}$$

The integral time can be set between 10 and 1200 seconds (20 minutes). The default value is 300 seconds (5 minutes). For room temperature control the integral time should be chosen above 120 seconds (2 minutes), since the temperature change needs in minimum several minutes to take place after heating or cooling valve was changed.

### 5.8.4 on/off control

The diagrams show the on/off control sequence for all applications except 4-pipe heating and cooling (P200 = 4) which is explained below.

Parameters	Parameter Description	Valid values for given chart
P200	Application mode	Not 6 (0 - 5, 7 - 8)
P201	Enable electric heater	0 or 1
P203	Valve Type	0 (= on/off valve)

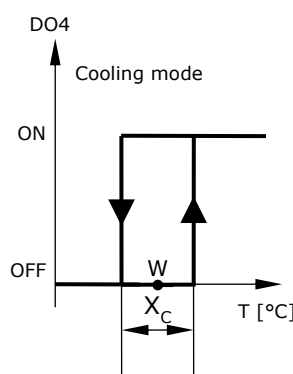
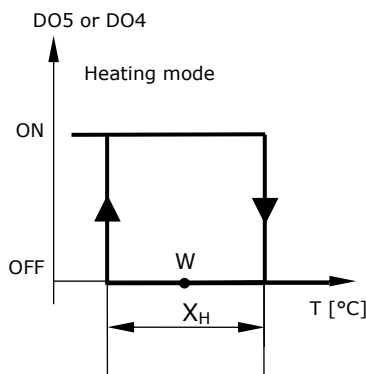

#### Legend

- $X_H$  Switching span heating
- $X_C$  Switching span cooling
- W Set point



**5.8.5 on/off control for 4-pipe application heating and cooling mode**

Parameters	Parameter Description	Valid values for given chart
P200	Application mode	6 (= 4-pipe heating and cooling)
P201	Enable electric heater	0
P203	Valve Type	0 (= on/off valve)

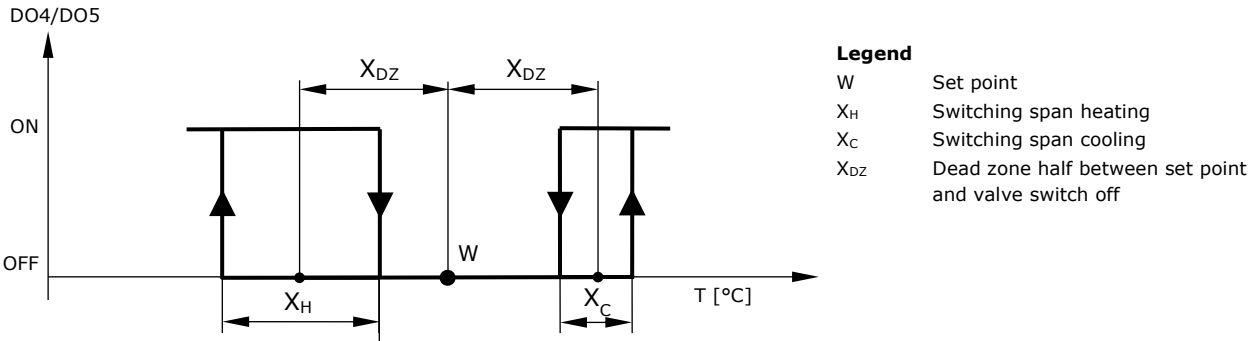

Note: X<sub>H</sub> and X<sub>C</sub> must be smaller 2\*X<sub>DZ</sub>.

**5.8.6 3-position control**

Parameters	Parameter Description	Valid values for given chart
P200	Application mode	0 - 3, 7 - 8
P201	Enable electric heater	0
P203	Valve Type	1 (= 3-position valve)

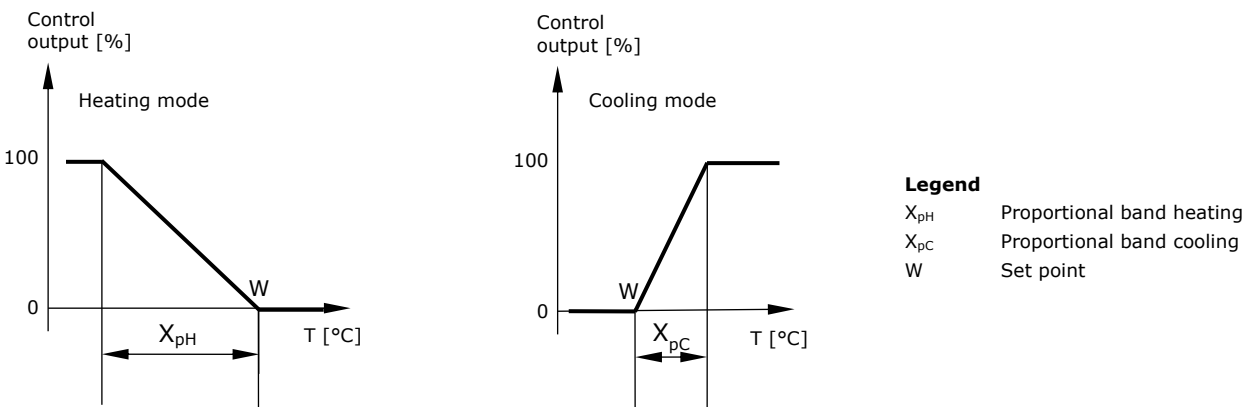

**5.8.7 Fan control in automatic mode (on/off control)**

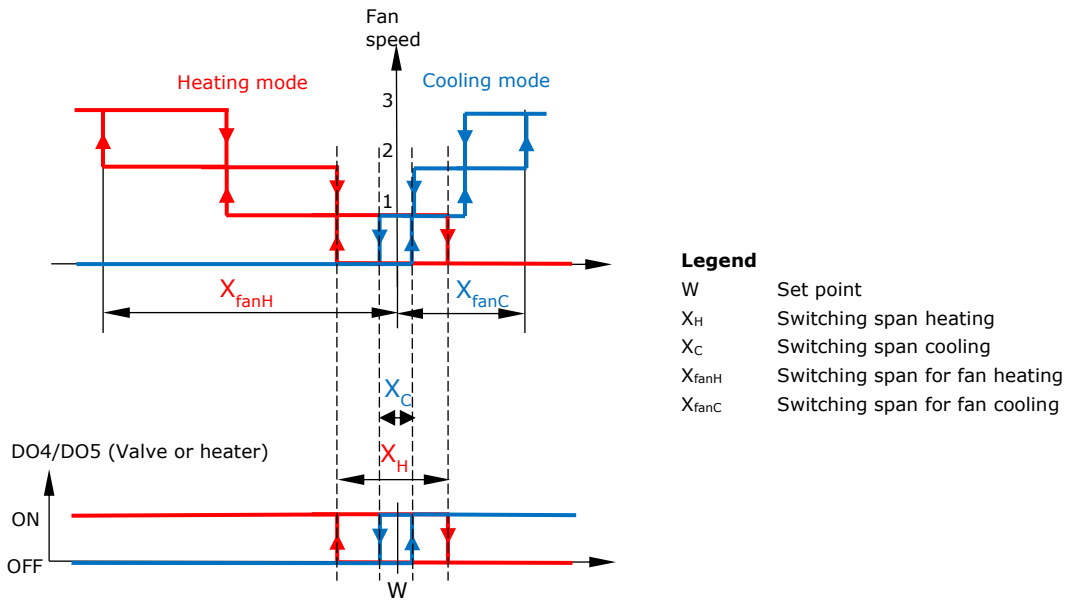

Note:

- Fan is off only if the valve (or electric heater) is turned off.
- This chart shows the fan control for 2-pipe and 4-pipe heating or cooling applications (P200 = 0 to 5). For 4-pipe heating and cooling application (P200 = 6), the dead zone between heating and cooling switch point is not depicted.
- This chart assumes P213 (Minimum fan speed in auto mode) is set to 0 = Fan off (default).

Fan speed 1 is aligned with on/off valve (or electric heater). If the valve (or electric heater) switches ON for heating/cooling then the fan speed 1 is switched ON. If the valve (or electric heater) switches OFF then the fan speed is switched OFF (in case P213 minimum fan speed in auto mode is 0)

X <sub>H</sub> / X <sub>C</sub> [°C]	0.5	1.0	1.5	2.0	2.5	3.0	3.5	4.0	4.5
X <sub>fanH</sub> / X <sub>fanC</sub> [°C]	2	3	4	5	6	7	8	9	10

For the remaining X<sub>H</sub> / X<sub>C</sub>: X<sub>fanH</sub> = X<sub>H</sub> \* 2 + 1 and X<sub>fanC</sub> = X<sub>C</sub> \* 2 + 1

**5.8.8 Fan control in automatic mode (3-position control)**

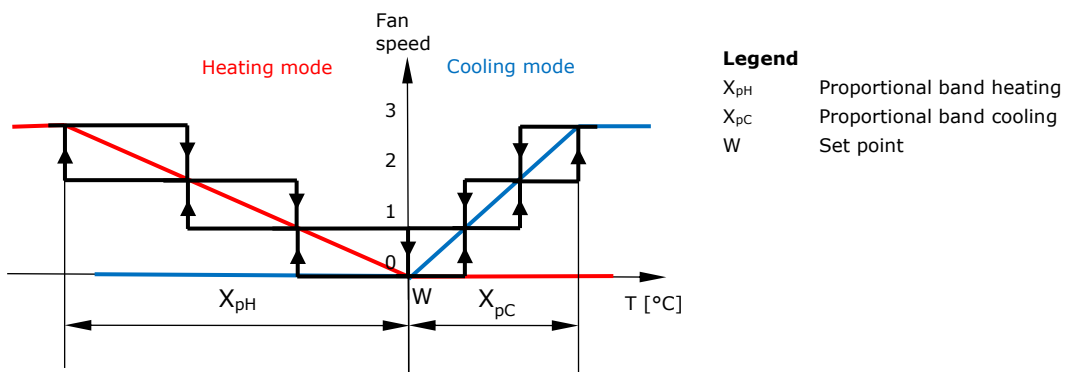

## 5.9 Temperature and digital inputs

### 5.9.1 Parameter P5xx overview

With parameter P500 – P503 input type and functionality of RT1 and RT2 can be set.

With parameter P504 – P505 the automatic heat/cool changeover level can be set.

With parameter P506 the built-in temperature sensor calibration (temperature offset) can be set.

If RT1/2 is set to 0 = NTC and an open or short circuit is detected, the error Err3 is generated.

Par/ Addr	Description	Data type / value	Default	R/ W
P500	Input RT1 Configuration	0 = Not assigned 1 = Control input instead of built-in temperature sensor (NTC) 2 = Heat/cool changeover or floor temperature sensor (NTC or DI) 3 = Occupation sensor – Comfort / Economy (DI) 4 = Occupation sensor – Comfort / Protection (DI) 5 = Door switch (DI, in combination with occupation sensor on RT2) 6 = Electric heater enable (DI) 7 = Dew point sensor (DI)	0	R/ W
P501	Definition of RT1	0 = NTC temperature sensor 1 = Normally Open (DI) 2 = Normally Closed (DI)	0 = NTC	R/ W
P502	Input RT2 Configuration	0 = Not assigned 1 = Control input instead of built-in temperature sensor (NTC) 2 = Heat/Cool changeover or floor temperature sensor (NTC or DI) 3 = Occupation sensor – Comfort / Economy (DI) 4 = Occupation sensor – Comfort / Protection (DI) 5 = Not used 6 = Electric heater enable (DI) 7 = Dew point sensor (DI)	0	R/ W
P503	Definition of RT2	0 = NTC temperature sensor 1 = Normally Open (DI) 2 = Normally Closed (DI)	1 = NO	R/ W
P504	Automatic heat/cool changeover level for cooling	Multiplier: 10 5.0...20.0 °C	15.0 °C	R/ W
P505	2-/4-pipe system: Automatic heat/cool changeover level for heating Floor heating system: Floor temperature limit	Multiplier: 10 20.0...40.0 °C	30.0 °C	R/ W
P506	Built-in temperature sensor calibration	Multiplier: 10; Integer (signed) -3.0...+3.0 °C	0.0 °C	R/ W

### 5.9.2 P500/502: 2 = Heat/cool changeover or floor temperature sensor (NTC or DI)

#### Heat/cool changeover (NTC or DI)

P200 (Application mode) must be set to 3 or 5. Otherwise an error occurs (Err4).

If P501/P503 = 0 = NTC temperature sensor, the controlling mode changes to cooling mode if the temperature on RT1/2 is lower than specified in P504. The controlling mode changes to heating if the temperature on RT1/2 is higher than specified in P505.

If RT1 and RT2 are not specified as Heat/cool changeover, the controlling mode changes to fan only. If the heat/cool changeover sensor defined as NTC has a short circuit or open contact, the controlling mode changes to fan only.

#### Floor temperature sensor (NTC)

P200 (Application mode) must be set to 7 (Floor heating system) and the corresponding P501/P503 = 0 = NTC. Otherwise, an error occurs (Err4).

If the floor temperature sensor exceeds the floor temperature limit (P505), the heating valve is turned off until the floor temperature is 2°C lower than the floor temperature limit.

**5.9.3 P500: 5 = Door switch (DI) and P502: 3 or 4 = Occupation sensor (DI)**

As soon as P500 is set to 5 = Door switch and P502 is set to 3 or 4 = Occupation sensor, the device is configured as "fool-proof presence detection". If P502 is set to another value than 3 or 4 an error (Err4 and P502) is shown.

The use of a key switch may be avoided by using a door contact and a motion detector. The room will go to Economy mode (P502 = 3) or Protection mode (P502 = 4) 60 seconds after the door is opened and closed again and if there is no movement in the room after the door closes (RT2 is evaluated 30 seconds after the door is opened and closed).

If there is movement in the room or the door is opened; the room will go to Comfort mode again and stays in Comfort mode unless the door is opened and closed again.

The motion detectors should be placed in each room in order to detect the presence of an occupant. Keep the delay of the motion detector output below 30 seconds.

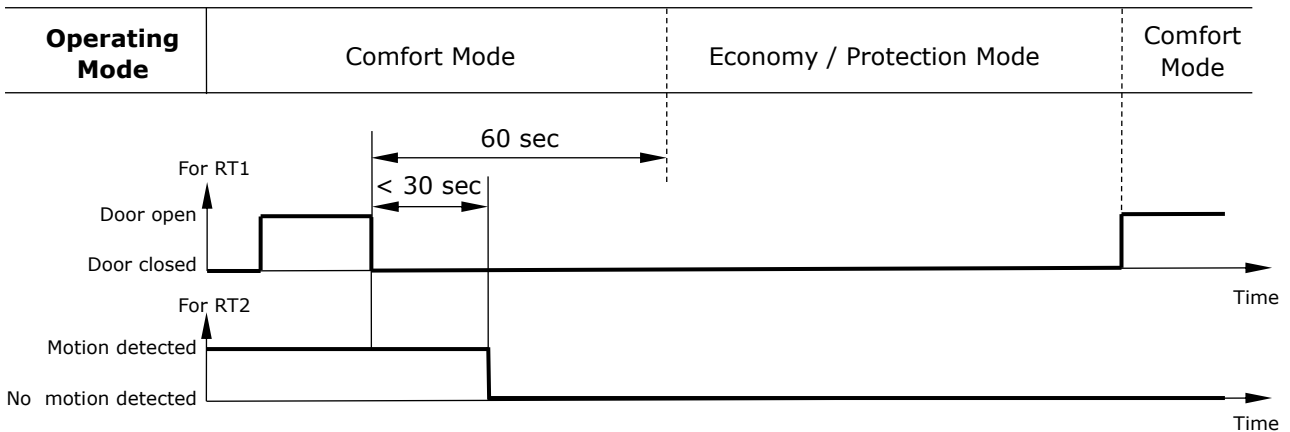

**5.9.4 P500/502: 7 = Dew point sensor**

Dew point sensor are used for cooling applications (chilled ceiling, etc.) to avoid condensation. A dew point sensor with digital output (open contact) is connected to RT1/2. If there is a condensation alarm the cooling valve is closed and cooling control output is set to 0 (D1301). In cooling mode the fan speed is set to 1 if there is condensation alarm.

**5.9.5 P500/502 digital input assignment**

If P501/P503 is in digital input mode the function or mode assignment for open and close contact are listed here:

Configuration of RT1/2 (P500/P502)	Definition of RT1/2 (P501/P503)	Contact open	Contact closed
2 = Heat/cool changeover (NTC or DI)	1 = Normally Open (DI)	Heating	Cooling
	2 = Normally Closed (DI)	Cooling	Heating
3 = Occupation sensor - Comfort / Economy (DI)	1 = Normally Open (DI)	Economy	Comfort
	2 = Normally Closed (DI)	Comfort	Economy
4 = Occupation sensor - Comfort / Protection (DI)	1 = Normally Open (DI)	Protection	Comfort
	2 = Normally Closed (DI)	Comfort	Protection
5 = Door switch (DI, in combination with occupation sensor of other input)	1 = Normally Open (DI)	Door closed	Door open
	2 = Normally Closed (DI)	Door open	Door closed
6 = Electric heater enable (DI)	1 = Normally Open (DI)	Electric heater disable	Electric heater enable
	2 = Normally Closed (DI)	Electric heater enable	Electric heater disable
7 = Dew point sensor (DI)	1 = Normally Open (DI)	No alarm	Dew point alarm
	2 = Normally Closed (DI)	Dew point alarm	No alarm

## 5.10 Load and store default settings

### 5.10.1 With user interface

Press up and down for minimum 3 seconds to enter the password protected default settings.

Enter the default settings with CODE 245. Choose between default TRA-F121-A "dEF" and OEM "OE" configuration copy menu. Navigate with Up (▲), Down (▼), Enter (↵) and Return Buttons (↻, ↺).

After a load or store action the small digits show "Good" and the default settings menu is closed.

Large Digits	Small Digits	Action with Enter Button (↵)
dEF	no LOAD	No action Load default TRA-F121-A configuration (as described in this manual)
OE	no LOAD SAVE	No action Load default OEM configuration Save default OEM configuration

### 5.10.2 With Modbus

Via Modbus the default settings can be accessed by writing 2 registers (with function code 0x16 write multiple registers) to data address 37. After a load or store command via Modbus, the small digits show "Good" and the large digits show "CPy" on the user interface.

Addr	Description	Required Qty	Data type	R/W
37	Default configuration type	2 registers (function code 0x16: write multiple registers)	0 = Default TRA-F121-A configuration 1 = OEM default configuration	W
38	Action for default configuration		0 = No action 1 = Load config. as defined with address 37 2 = Save actual config. to OEM default (only valid when address 37 = 1)	W

## 6 Runtime Data

### 6.1 Resolution and data format

All temperature related data are given in °C for Modbus. Only in the user interface values can be shown in °F.

Data without multiplier have resolution 1. Data with multiplier 10 have resolution 0.1.

For example, the default value of Comfort temperature set point (P300) is 20.0°C and the value read via Modbus is 200 (because of multiplier 10 used for P300).

Data with values below 0 (zero) are given as signed integer values.

### 6.2 Modbus access

The controller supports the following Modbus function codes:

Modbus function code	Data
Read multiple register (0x03)	Read n registers (n x 2 bytes) starting from requested address.
Write register (0x06)	Write 1 register (2 bytes) at requested address.
Write multiple registers (0x16)	Write n register (n x 2 bytes) starting from sent address.

Note: The read/write capability of each data element is defined in column "R/W". Most data can be read and written defined as "R/W". Read only data are defined as "R".

### 6.3 Address table of controller runtime data

Data/ Addr	Description	Data type / value	Default	R/W
1000	Vector product series information	20 = TRA-F121-A	20	R
1001	Product type information	0 = Standard version	0	R
1002	Controller software version	n = Version n	none	R
1003	Controller software revision	n = Revision n	none	R
1004	Alarm	0 = No alarm 1 = Dew point alarm from RT1/2 (P500/502 = 7) 2 = Overheat protection alarm 3 = Frost protection alarm	0	R
1005	Error	0 = No error 1 = Built-in temperature sensor error 2 = Temperature sensor RT1/RT2 error 3 = Digital input is not open/close 4 = Configuration error 5 = Time error (time not set)	0	R
1100	Operating mode	0 = Comfort 1 = Economy 2 = Protection	0	R/W
1101	Controlling mode	0 = Heating 1 = Cooling 2 = Fan only	0	R/W
1102	Fan speed value	0 = Fan off 1 = Low Fan 2 = Mid Fan 3 = High Fan	1	R/W
1103	Fan mode	0 = Automatic 1 = Manual (set to manual if fan speed value changed from Modbus master)	0	R/W
1200	Room temperature (Built-in sensor)	Multiplier: 10; Integer (signed) -20.0...60.0 °C (-4.0...140 °F) -100.0 (= 0xFC18) = Sensor damaged	none	R
1201	External temperature RT1	Multiplier: 10; Integer (signed) -20.0...60.0 °C (-4.0...140 °F) -100.0 (= 0xFC18) = none (digital input)	none	R
1202	External temperature RT2	Multiplier: 10; Integer (signed) -20.0...60.0 °C (-4.0...140 °F) -100.0 (= 0xFC18) = none (digital input)	none	R

<b>Data/ Addr</b>	<b>Description</b>	<b>Data type / value</b>	<b>Default</b>	<b>R/ W</b>
1203	Outdoor temperature Modbus	Multiplier: 10; Integer (signed) -20.0...60.0 °C -100.0 (= 0xFC18) = no valid temperature received yet	none	R/ W
1204	RT1 digital input	0 = OFF 1 = ON -1 = none (Temperature input)	none	R
1205	RT2 digital input	0 = OFF 1 = ON -1 = none (Temperature input)	none	R
1300	Heating control output	0...100 %	none	R
1301	Cooling control output	0...100 %	none	R

## 7 Additional Information

### 7.1 Conventions

The following presentation conventions apply to this manual:



**DANGER**

Indicates a hazard with a high degree of risk. Failure to observe this warning may result in immediate danger of serious injury or death.



**Information**

Further information, important operating instructions, other details.



Reference to another document or other text passages.

### 7.2 Abbreviations used

Abbr.	Meaning
DI	Digital input
DO (n)	Digital output
GND	Ground
NC	Normally closed
NO	Normally open
NTC	Negative Temperature Coefficient
REF	Reference
RH	Relative humidity
RT (n)	Input (DI or NTC sensor)
STP	Shielded Twisted Pair (Cable)



Empty page.

## **Smart Sensors and Controls Made Easy!**

## **Quality - Innovation – Partnership**

Vector Controls GmbH  
Switzerland

[info@vectorcontrols.com](mailto:info@vectorcontrols.com)  
[www.vectorcontrols.com](http://www.vectorcontrols.com)

